



## *Distal Volar Radius Plate Procedure Steps*



[www.carbo-fix.com](http://www.carbo-fix.com)

# Introduction

## The CarboFix™ Implants

The **CarboFix™** Distal Volar Radius Plates are made of numerous continuous carbon fibers embedded in polymer (PEEK).

The Carbon Fibers are arranged in a unidirectional longitudinal orientation, as well as in a diagonal orientation, allowing Tri-dimensional bending and rotational strength.

**CarboFix™** is the first FDA cleared and CE marked trauma line of intramedullary nails and anatomical plates made of composite material, overcoming the drawbacks of metals.

## The Advantages of CarboFix™ Implants

### Modulus of Elasticity

The **CarboFix™** implants have modulus of elasticity which is close to that of cortical bone, lowering the risk for stress risers and secondary fractures.

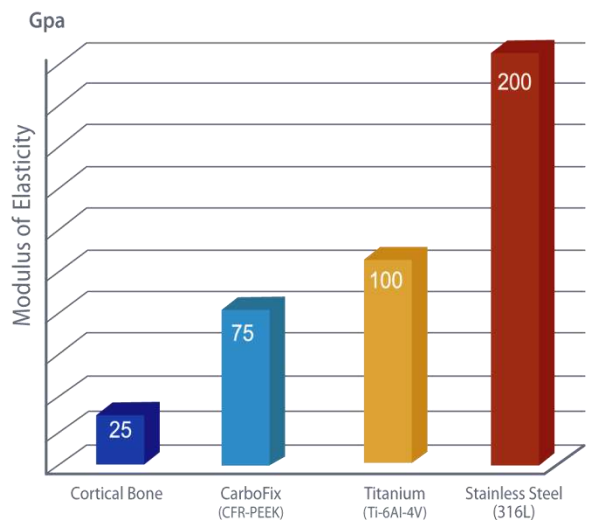

## Bending Strength

In comparison 4-point bending experiments of Diaphyseal plates, the **CarboFix™** plate was 33% stronger than a Synthes titanium plate, and 15% stronger than a Synthes stainless steel plate.

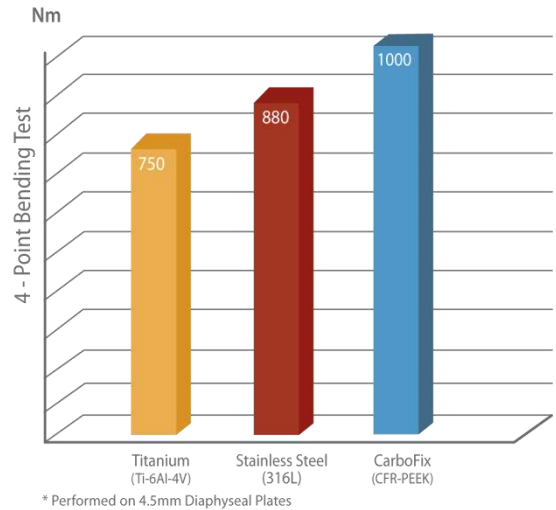

## Radiolucency

The **CarboFix™** implants allow easy positioning and better fracture monitoring during surgery and follow-up.



Metal Plate-fracture view is obstructed



CarboFix™ Plate-clear view of the fracture

## CT & MRI Imaging

The **CarboFix™** implants allow CT & MRI\* scans with no artifacts caused by the Carbon Fibers implant.

\* Please refer to page 18, and the product IFU.



Titanium Rod Ø5mm in MRI field: demonstrates massive artifacts

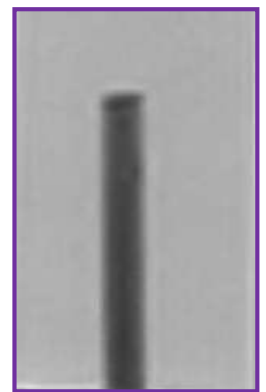

Carbon Fibers Rod Ø5mm in MRI Field-no artifacts

## Easy Removal

In contrast with titanium, no “Cold Welding” occurs between **CarboFix™** plates & screws, allowing easier hardware removal

# CarboFix™ Distal Volar Radius Plates

## The Plate

The main features of the **CarboFix™** Distal Volar Radius Plates:

- Anatomically shaped
- Low profile plate: 2.4mm
- Circumference radiopaque marking outlining the plate contour for positioning & follow-up (A)
- Compatible screw holes for locking or non-locking screws
- Similar instrumentation & procedure steps as conventional metal plates

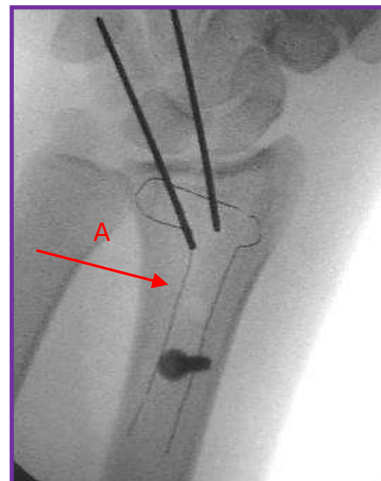

Plate under X-ray after initial positioning

Right & left, Standard, Narrow & Triangular plates are available as follows:

Description	Standard / Narrow	No. of holes (Shaft)	Length (mm)	Right / Left
CarboFix Distal Volar Radius Plate 3/R	Standard / Narrow	3	52	Right
CarboFix Distal Volar Radius Plate 3/L	Standard / Narrow	3	52	Left
CarboFix Distal Volar Radius Plate 4/R	Standard / Narrow	4	60	Right
CarboFix Distal Volar Radius Plate 4/L	Standard / Narrow	4	60	Left
CarboFix Distal Volar Radius Plate 7/L	Standard	7	90	Right
CarboFix Distal Volar Radius Plate 7/L	Standard	7	90	Left

CarboFix Triangular Distal Radius Plate 3/R	Triangular	3	54	Right
CarboFix Triangular Distal Radius Plate 3/L	Triangular	3	54	Left
CarboFix Triangular Distal Radius Plate 4/R	Triangular	4	63	Right
CarboFix Triangular Distal Radius Plate 4/L	Triangular	4	63	Left

## *Standard Plates*



3 Holes, 52mm  
Standard Plate



4 Holes, 60mm  
Standard Plate

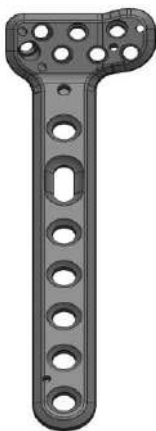

7 Holes, 90mm  
Standard Plate

## *Narrow Plates*



3 Holes, 52mm  
Narrow Plate

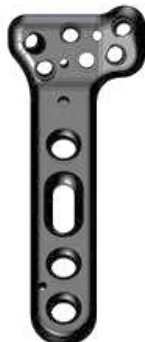

4 Holes, 60mm  
Narrow Plate

## *Triangular Plates*



3 Holes, 54mm  
Triangular Plate



4 Holes, 63mm  
Triangular Plate



# The Standard & Narrow Plates

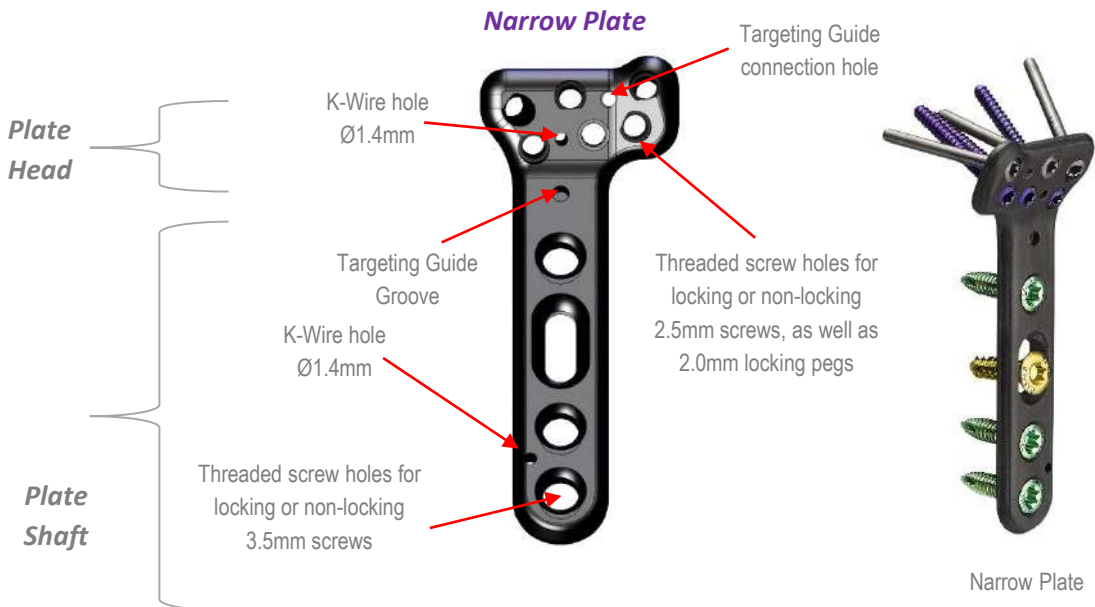
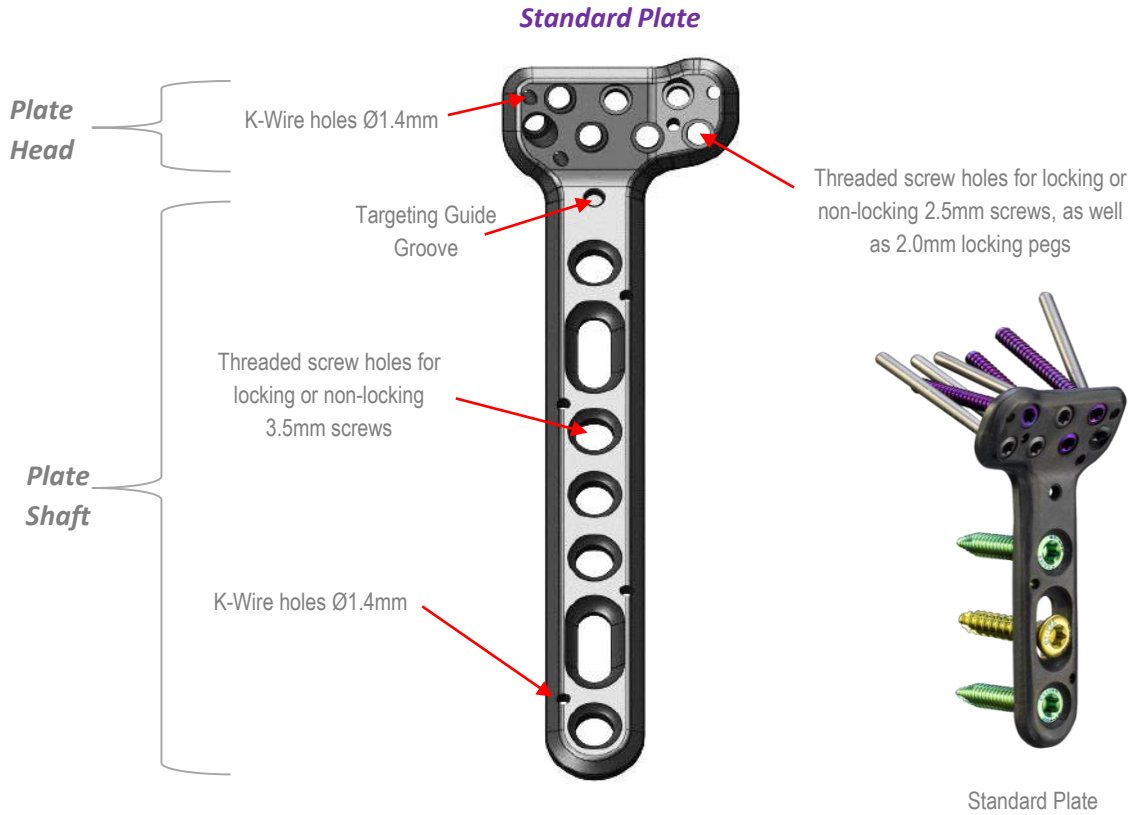

# The Triangular Plate

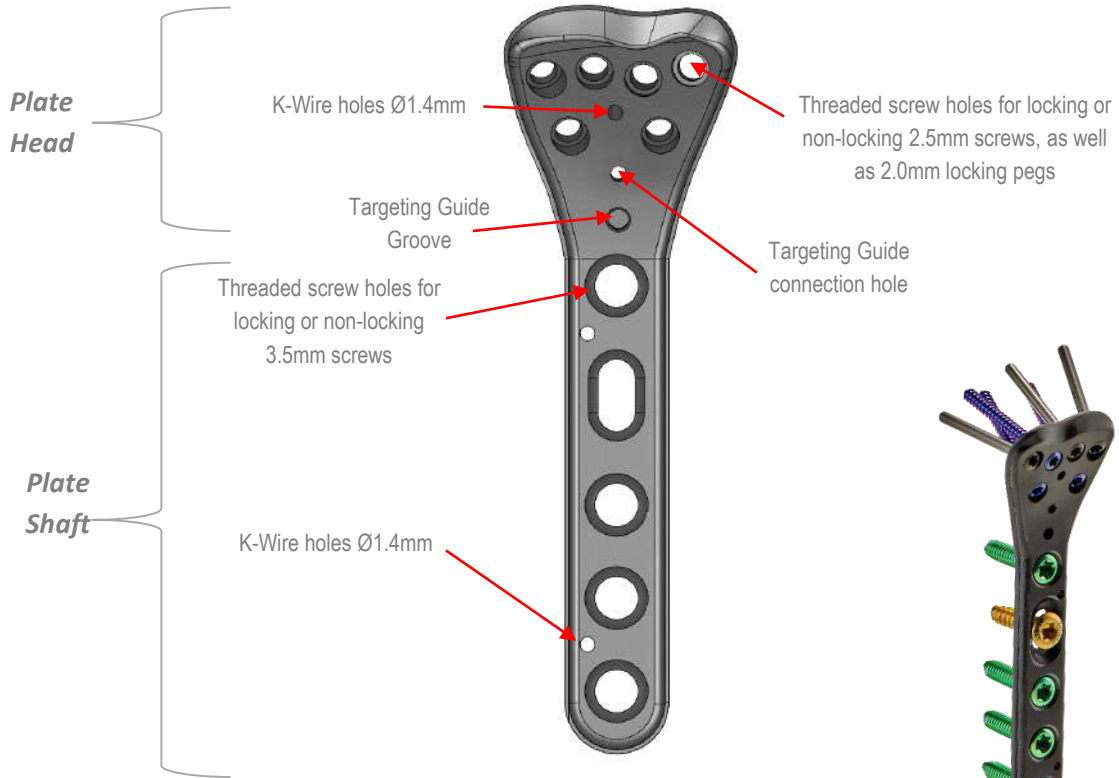



Triangular Plate



# The Screws

Proprietary self-tapping titanium screws are used to fixate the plate:

## Plate Head

Description	Diameter (mm)	Lengths (mm)	Screw color	Drill Bit Diameter (mm)	
Head Locking Pegs	2.0	14-26 (2mm increments)	Gray	2.0	
Head Locking Screws	2.5	14-26 (2mm increments)	Purple	2.0	
Head Non-Locking Screws	2.5	14-26 (2mm increments)	Blue	2.0	

## Plate Shaft

Description	Diameter (mm)	Lengths (mm)	Screw color	Drill Bit Diameter (mm)	
Shaft Locking Screws	3.5	10-18 (2mm increments)	Green	3.0	
Shaft Non-Locking Screws	3.5	10-18 (2mm increments)	Yellow	2.5	

# Instrumentation Set

## Reduction Tools (optional)

The set may include several instruments for exposure of the surgical site, as well as for fracture reduction:

- Hohmann Retractors
- Periosteal Elevator
- Lobster Claw Forceps
- Bone Reduction Forceps

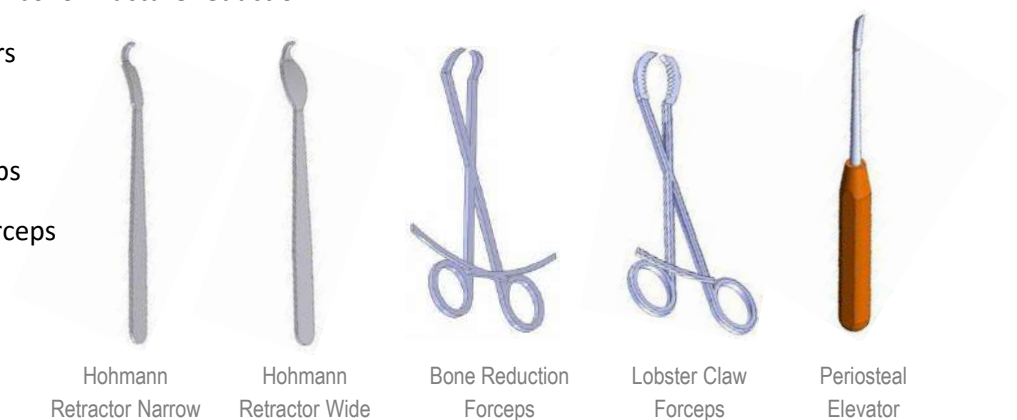



### **Plate Template**

The plate template is used to determine the desired plate length. Right & left templates are available for the 3, 4 & 7 holes Standard Plate.

Right & left templates are available for the 3 & 4 holes Narrow & Triangular Plates.

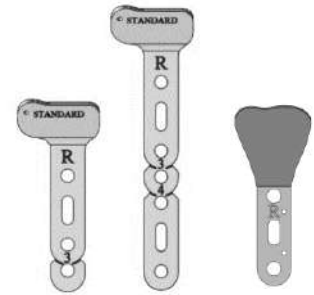

### **Targeting Guide (Jig)**

The Targeting Guide (Jig) is mounted on the plate head. It is an aiming device assisting the surgeon in drilling the holes in the correct trajectory. There are three sets of Targeting Guides, for the Standard, Narrow, as well as for the Triangular Plate.



### **Ø1.4mm K-Wire**

The Ø1.4mm K-wire assists the surgeon in positioning the plate, as well as in fracture reduction.

The K-wires may be inserted through the designated holes at the plate shaft, as well as through the Targeting Guide & plate head designated holes.

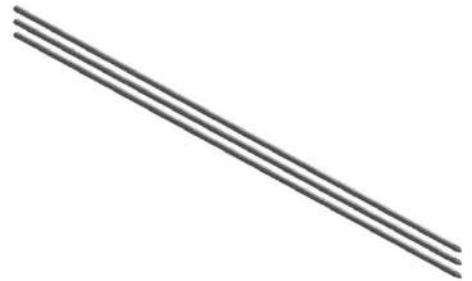

### **Free Hand Drill Sleeve Ø2.0mm / Ø2.5mm**

The Free Hand Drill Sleeve is used for drilling holes for the non-locking screws in the shaft. The arm is yellow marked. The Ø2.0mm arm is designed for drilling the Distal Radius Head screw holes. It is calibrated to enable measuring the required screw length.

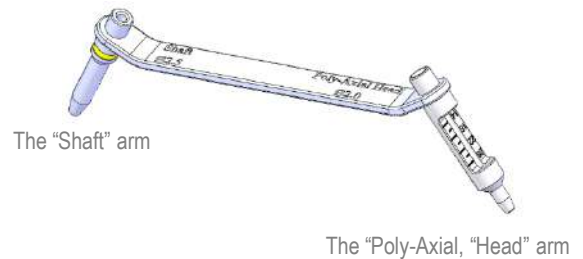

### **Shaft Drill Sleeve Ø3.0mm**

The Shaft Drill Sleeve is used for drilling the holes for locking screws at the plate shaft, using the Ø3.0mm Drill Bit.



### Targeting Guide Drill Sleeve Ø2.0mm

The Guide Drill Sleeve is used for drilling the holes for the locking screws or pegs at the plate head, using the Ø2.0mm Drill Bit.

It is inserted into the Targeting Guide designated holes. It has markings to enable measuring the required screw length.



### Drill Bits Ø2.0mm, Ø2.5mm, Ø3.0mm

Three different Drill Bits are available:

- **Ø2.0mm:** For drilling the plate head screws. A circumference marker on the Drill enables screw length measurement (A).
- **Ø2.5mm:** For drilling the non-locking plate shaft screws. Marked Yellow **Yellow (B)**.
- **Ø3.0mm:** For drilling the locking shaft screws. Marked **Green (C)**.

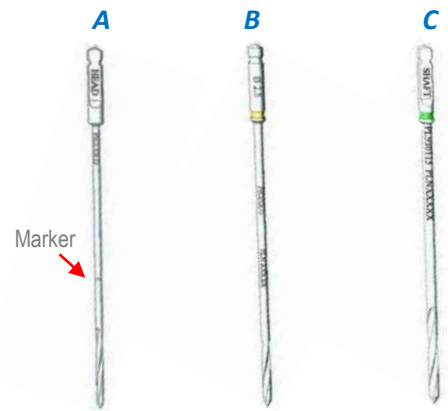

For Screws/Drill Bits compatibility, Please refer to the table in page 7.

### Screwdriver

The Screwdriver includes a Handle as well as 2 different detachable rods:

- A rod for the shaft screws-marked "Shaft"
- A rod for the head screws-marked "Head"

The tip of the screwdriver rods is Torx shaped.

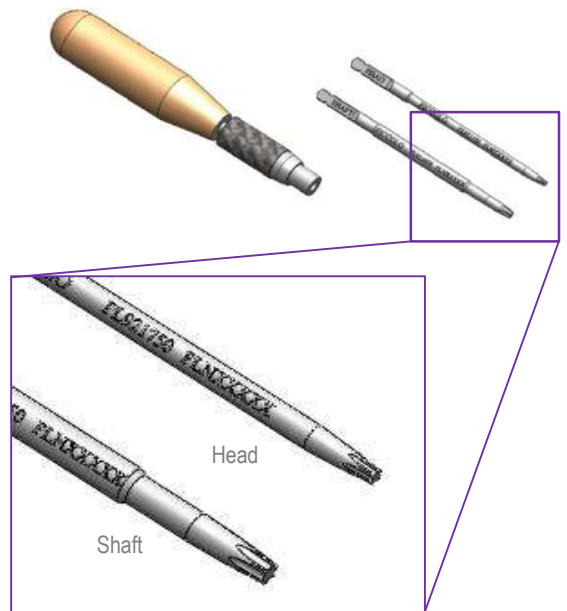

### Depth Gauge

The Depth Gauge assists in determining the desired screw length.



### Torque Limiter 0.8Nm (optional)

The Torque Limiter is used for insertion of the plate head screws & pegs. Connects to the Handle on one side, and to the detachable screwdriver rod on the other side.



## Procedure Steps

1. Expose the bone according to routine surgical technique. Reduce the fracture using reduction tools and determine the required plate length using the plate templates. Right & Left / Standard & Narrow templates are available for the 3 & 4 holes plates, as well as a for the 7 holes plates.

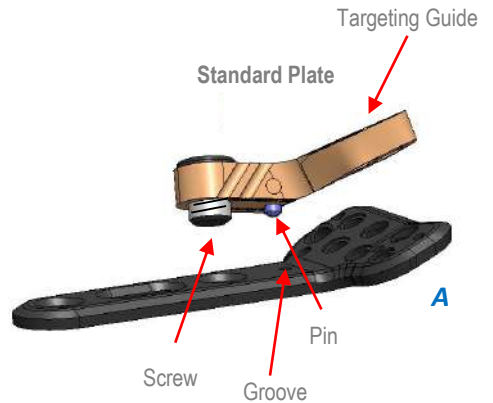

2. **Standard Plate:** Connect the Targeting Guide to the plate head. Use the right or left Targeting Guide according to the plate. Align the Targeting Guide to the plate by positioning the Guide's pin into the designated groove in the plate (A). Use the "Shaft" Screwdriver and tighten the Guide to the plate by screwing the Targeting Guide screw into the most distal hole of the Plate shaft (B).

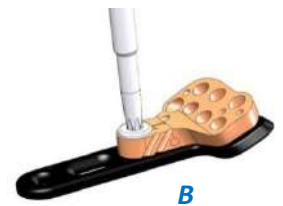

**Narrow/Triangular Plate:** Connect the Targeting Guide to the plate head. Use the right or left Targeting Guide according to the plate. Align the Targeting Guide to the plate by positioning the Guide's pin into the designated groove in the plate (A). Use the "Head" Screwdriver and tighten the Guide to the plate by screwing the Targeting Guide screw into the designated screw hole at the Plate head (B).

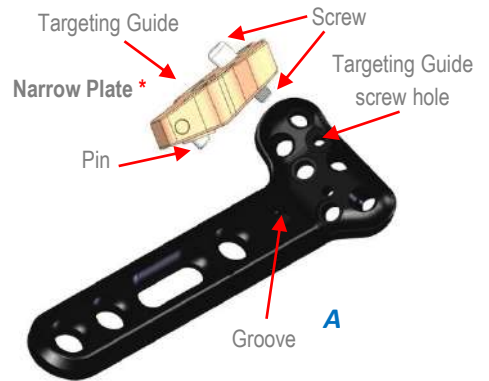

**3.** Place the Plate over the bone, so it will conform to the surface of the volar radius. If desired, secure the Plate to the bone with the  $\varnothing$ 1.4mm K-Wires, placed within the K-Wire holes located along the Plate shaft and/or Plate head (C). If needed, bend the K-wires to facilitate drilling. Verify placement under X-ray.

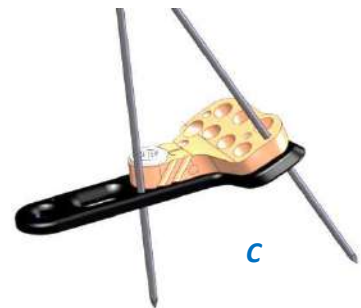

4. For initial fixation and positioning of the plate, use  $\varnothing 2.5$  mm Drill Bit, (marked **Yellow**) through the Free Hand Drill Sleeve-it's "Shaft" arm (marked Yellow), and drill through the oval hole of the Plate shaft (A).

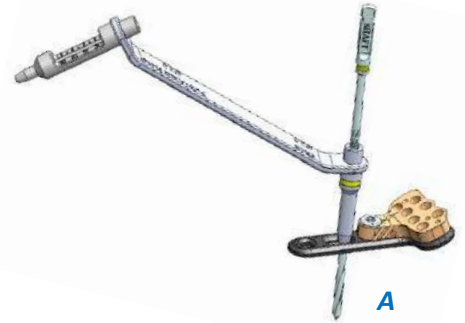

Determine the required non-locking Cortical Screw length using the Depth Gauge. Use the flat Depth Gauge Scale, marked "Shaft", for reading the required screw length (B).

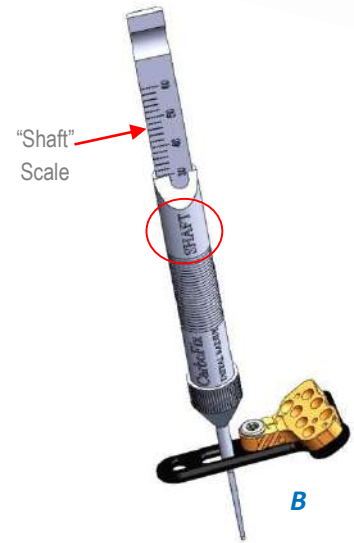

Insert the Cortical Screw using the Screwdriver with the larger tip (marked "Shaft") and tighten it in place(C) \*.

Verify placement under X-ray.

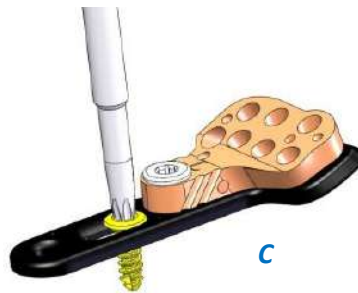

**\* Do not apply high torque during Screw tightening; excessive torque may damage the bone or implant.**

5. Attach the Targeting Guide Drill Sleeve to the Targeting Guide, at the desired location, and use the  $\varnothing 2.0$  mm Drill Bit (D). Drill the required holes. Verify drill trajectory and location under X-ray.



## Poly-Axial Screw Insertion

The Targeting Guide may be used only for the insertion of screws along the axis perpendicular to the hole surface.

If screw insertion at a different angle is desired, the Free Hand Drill Sleeve  $\varnothing 2.0 / \varnothing 2.5\text{mm}$  should be used.

The Locking Screws provide for multi-axial locking range of  $\pm 10^\circ$ .

Prior to drilling, the Drill Guide (the arm having the calibrated sleeve) shall be placed at the desired angle, and the  $\varnothing 2.0$  Drill Bit should be used for drilling the screw hole (C).

The thread at the Screw head shapes the thread of the Plate hole to provide for locking of the Screw to the Plate at the desired angle.

6. Measure the length of the required screws/pegs using the Targeting Guide Drill Sleeve and the circumference Drill Bit mark (B).

As alternative, the required length of the screws/pegs can be determined by using the rounded Depth Gauge Scale, marked "Head" (C).

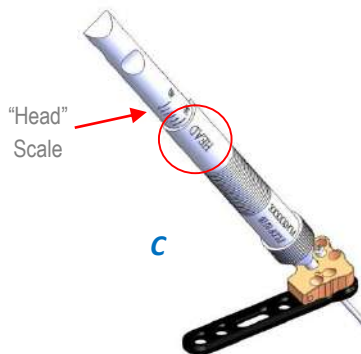
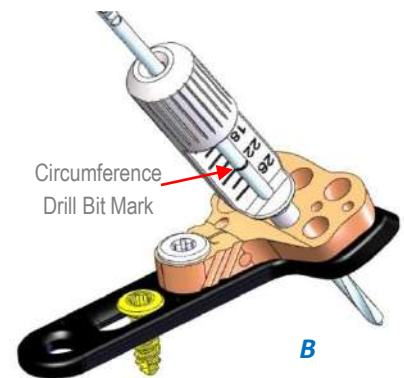



Choose the desired screw or peg (please refer to the table in page 7).

If available, attach the 0.8Nm Torque Limiter to the Screwdriver Handle and its rod, marked "*Head*", and insert the Locking Screw/Pegs. Tighten the Screw/Peg until the Torque Limiter "clicks" (C).

\* If a Torque Limiter is not available, "Finger Tighten" the Screws/Pegs (D). Verify placement under X-ray.

Repeat these steps for the rest of the "plate head" holes.

Remove the Targeting Guide.

Observe the Screws, and if needed, tighten using the Screwdriver (without the Torque Limiter), until flush with the plate (E).

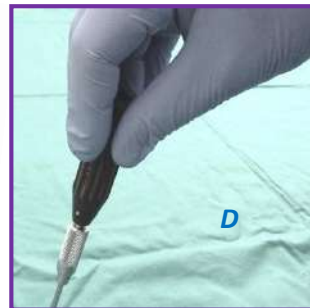
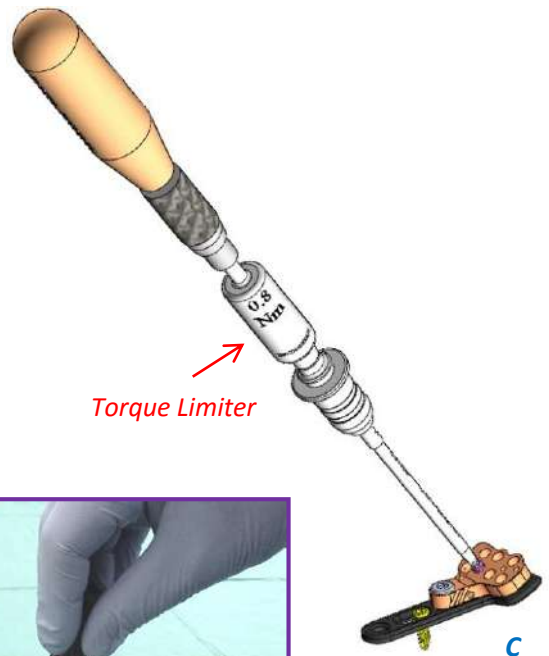

Finger Tightening



7. Apply the rest of the shaft screws:

### Locking Screws:

Connect the Shaft Drill Sleeve to the desired threaded hole of the Plate shaft.

The large tip Screwdriver rod marked “*Shaft*”, can be used to attach /detach the Shaft Drill Sleeve to/from the plate (A).

Use the  $\varnothing 3.0$  mm Drill Bit (marked **Green**), placed through the Shaft Drill Sleeve, and drill the required hole (B).

Detach the Shaft Drill Sleeve, and measure the desired Screw length using the Depth Gauge. Use the flat Depth Gauge Scale, marked “*Shaft*”, for reading the required screw length.

Insert the Locking Screw (**Green**) using the Screwdriver marked “*Shaft*” and tighten it in place \*.

Verify placement under X-ray.

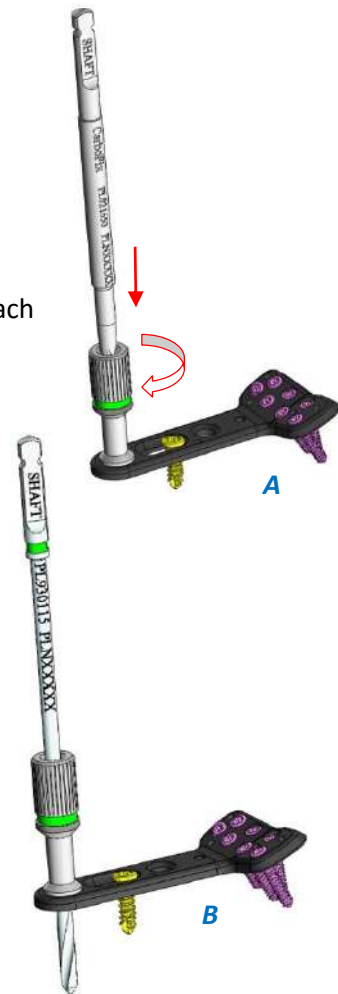

### Non-Locking Screws:

Use the  $\varnothing 2.5$  mm Drill Bit (marked **Yellow**), through the Free Hand Drill Sleeve, and drill through the threaded/oval hole of the Plate shaft.

Determine the required Cortical Screw length using the Depth Gauge. Use the flat Depth Gauge Scale, marked “*Shaft*”, for reading the required screw length (C).

Insert the Non-Locking Screw (**Yellow**) using the Screwdriver rod with the bigger Torx tip (marked “*Shaft*”) \*, and tighten it in place (refer to page 12, images A, B, C).

Verify placement under X-ray.

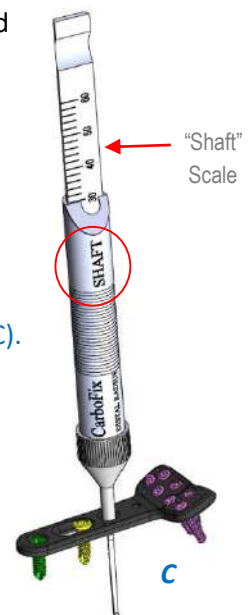

8. Remove any remaining K-Wires. Close the incision according to routine surgical procedure.

**\* Do not apply high torque during Screw tightening; excessive torque may damage the bone or implant.**

# Ordering Information

## Instrumentation

Cat. No.	Description
PL921010USA	Distal Radius Plate Instrumentation Set (Not Including Screws)

## Plates

Cat. No.	Description	Length (mm)	No. of holes (Shaft)	Standard/Narrow	Right / Left
PRRNN2403	CarboFix Distal Volar Radius Plate 3/R/S	52	3	Standard	Right
PRLNN2403	CarboFix Distal Volar Radius Plate 3/L/S	52	3	Standard	Left
PRRNN2404	CarboFix Distal Volar Radius Plate 4/R/S	60	4	Standard	Right
PRLNN2404	CarboFix Distal Volar Radius Plate 4/L/S	60	4	Standard	Left
PRRNN2407	CarboFix Distal Volar Radius Plate 7/L/S	90	7	Standard	Right
PRLNN2407	CarboFix Distal Volar Radius Plate 7/L/S	90	7	Standard	Left

PRRSN2403	CarboFix Distal Volar Radius Plate 3/R/N	52	3	Narrow	Right
PRLSN2403	CarboFix Distal Volar Radius Plate 3/L/N	52	3	Narrow	Left
PRRSN2404	CarboFix Distal Volar Radius Plate 4/R/N	60	4	Narrow	Right
PRLSN2404	CarboFix Distal Volar Radius Plate 4/L/N	60	4	Narrow	Left

PRRTN2203	CarboFix Triangular Distal Radius Plate 3/R/T	54	3	Triangular	Right
PRLTN2203	CarboFix Triangular Distal Radius Plate 3/L/T	54	3	Triangular	Left
PRRTN2204	CarboFix Triangular Distal Radius Plate 4/R/T	63	4	Triangular	Right
PRLTN2204	CarboFix Triangular Distal Radius Plate 4/L/T	63	4	Triangular	Left

## Screws: Plate Head

### Head Locking Peg



Cat. No.	Description	Diameter (mm)	Length (mm)	No. Screws in Instrumentation Set
PSPST2014	Head Locking Peg 2.0 L=14	2.0	14	6
PSPST2016	Head Locking Peg 2.0 L=16	2.0	16	6
PSPST2018	Head Locking Peg 2.0 L=18	2.0	18	8
PSPST2020	Head Locking Peg 2.0 L=20	2.0	20	8
PSPST2022	Head Locking Peg 2.0 L=22	2.0	22	8
PSPST2024	Head Locking Peg 2.0 L=24	2.0	24	6
PSPST2026	Head Locking Peg 2.0 L=26	2.0	26	6

### Head Locking Screw



Cat. No.	Description	Diameter (mm)	Length (mm)	No. Screws in Instrumentation Set
PRTST2514	Head Locking Screw 2.5 L=14	2.5	14	5
PRTST2516	Head Locking Screw 2.5 L=16	2.5	16	5
PRTST2518	Head Locking Screw 2.5 L=18	2.5	18	7
PRTST2520	Head Locking Screw 2.5 L=20	2.5	20	7
PRTST2522	Head Locking Screw 2.5 L=22	2.5	22	7
PRTST2524	Head Locking Screw 2.5 L=24	2.5	24	5
PRTST2526	Head Locking Screw 2.5 L=26	2.5	26	5

### Head Non-Locking Screw



Cat. No.	Description	Diameter (mm)	Length (mm)	No. Screws in Instrumentation Set
PRAST2514	Head Non-Locking Screw 2.5 L=14	2.5	14	2
PRAST2516	Head Non-Locking Screw 2.5 L=16	2.5	16	2
PRAST2518	Head Non-Locking Screw 2.5 L=18	2.5	18	3
PRAST2520	Head Non-Locking Screw 2.5 L=20	2.5	20	3
PRAST2522	Head Non-Locking Screw 2.5 L=22	2.5	22	3
PRAST2524	Head Non-Locking Screw 2.5 L=24	2.5	24	2
PRAST2526	Head Non-Locking Screw 2.5 L=26	2.5	26	2

## Screws: Plate Shaft

### Shaft Non-Locking Screw



Cat. No.	Description	Diameter (mm)	Length (mm)	No. Screws in Instrumentation Set
PRCST3510	Shaft Non-Locking Screw 3.5 L=10	3.5	10	3
PRCST3512	Shaft Non-Locking Screw 3.5 L=12	3.5	12	4
PRCST3514	Shaft Non-Locking Screw 3.5 L=14	3.5	14	4
PRCST3516	Shaft Non-Locking Screw 3.5 L=16	3.5	16	4
PRCST3518	Shaft Non-Locking Screw 3.5 L=18	3.5	18	3

### Shaft Locking Screw



Cat. No.	Description	Diameter (mm)	Length (mm)	No. Screws in Instrumentation Set
PRTST3510	Shaft Locking Screw 3.5 L=10	3.5	10	4
PRTST3512	Shaft Locking Screw 3.5 L=12	3.5	12	5
PRTST3514	Shaft Locking Screw 3.5 L=14	3.5	14	5
PRTST3516	Shaft Locking Screw 3.5 L=16	3.5	16	5
PRTST3518	Shaft Locking Screw 3.5 L=18	3.5	18	4

## Miscellaneous

Cat. No.	Description
PL918115	Drill Bit $\varnothing$ 2.0x115mm <i>Single Use</i>
PL922115	Drill Bit $\varnothing$ 2.5x115mm (marked yellow) <i>Single Use</i>
PL930115	Drill Bit $\varnothing$ 3.0x115mm (marked green) <i>Single Use</i>
PL921210	K-Wire $\varnothing$ 1.4mm <i>Single Use</i>

# Instrumentation Set Components

Cat. No.	Description	Cat. No.	Description
PL921555	Sterilization Box	PL921650	Screwdriver Rod Torx 15-Large
PL921720	Targeting Guide Standard Left (Torx 15)	PLDF0210	Depth Gauge
PL921730	Targeting Guide Standard Right (Torx 15)	PL921103	Template Standard 3 & 4 Holes Right
PLL92100	Targeting Guide Narrow Left (Torx 7)	PL921203	Template Standard 3 & 4 Holes Left
PLR92110	Targeting Guide Narrow Right (Torx 7)	PL921107	Template Standard 7 Holes Right
PPL931110	Targeting Guide Triangular Left (Torx 7)	PL921207	Template Standard 7 Holes Left
PLR931100	Targeting Guide Triangular Right (Torx 7)	PRN92104	Template 3 & 4 Holes Narrow Right
PL921500	Targeting Guide Drill Sleeve $\varnothing$ 2.0mm	PLN92104	Template 3 & 4 Holes Narrow Left
PL921590	Shaft Drill Sleeve $\varnothing$ 3.0mm	PL921940	Template 3 Holes Triangular Right
PL922500	Free Hand Drill Sleeve $\varnothing$ 2.0mm / $\varnothing$ 2.5mm	PL921950	Template 3 Holes Triangular Left
PL918115	Drill Bit $\varnothing$ 2.0 X 115mm	PL921815	Hohmann Retractor Wide
PL922115	Drill Bit $\varnothing$ 2.5 X 115mm (marked yellow)	PL921808	Hohmann Retractor Narrow
PL930115	Drill Bit $\varnothing$ 3.0 X 115mm (marked green)	PL921800	Periosteal Elevator
PL921210	K-Wire $\varnothing$ 1.4mm	PLDF0190	Lobster Claw Forceps
PL921510	Screwdriver Handle	PL921810	Bone Reduction Forceps
PL921750	Screwdriver Rod Torx 7-small	PL920080	Torque Limiter 0.8Nm (Optional)

\* Maximal Contents



Distal Radius Plate Instrumentation Set



## Case I

Pre-OP

6 weeks Post-OP



## Case II

Triangular Plate

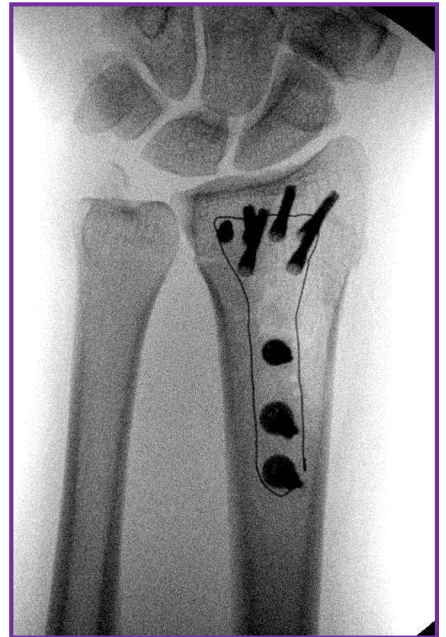

## MRI INFORMATION



The Piccolo Composite Plate System is MR-Conditional.

Non-clinical testing demonstrated that the Piccolo Composite Plate System is MR Conditional. A patient with this device can be scanned safely, immediately after placement under the following conditions:

- Static magnetic field of 1.5 Tesla and 3.0 Tesla.
- Maximum spatial gradient magnetic field of 720-Gauss/cm (72 mT/cm).
- Maximum whole body averaged specific absorption rate (SAR) of 4.0 W/kg in the First Level Controlled Mode.
- The Piccolo Composite Plate System must be entirely outside the MR scanner bore.

### Note:

It is recommended that patients register the conditions under which they can be scanned safely with the MedicAlert Foundation ([www.medicalert.org](http://www.medicalert.org)) or equivalent organization.



***www.carbo-fix.com***

For detailed procedure, indications, contraindications, possible adverse event, warnings and precautions, refer to the Instructions for Use

Caution: In the U.S.A., federal law restricts this device to sale by or on the order of a physician.

**MANUFACTURED BY:**

**CarboFix Orthopedics Ltd.**  
11 Ha'hoshlim St.,  
Herzeliya 46724, Israel  
Tel: +972-9-9511511  
Fax: +972-9-9548939  
E-Mail: info@carbo-fix.com

**U.S.A. OFFICE:**

**CarboFix Orthopedics Inc.**  
7183 Beach Dr. SW Ste 1  
Ocean Isle Beach, NC 28469, USA  
Tel: 1-800-408-0120  
E-Mail: usa@carbo-fix.com

**EC AUTHORIZED REPRESENTATIVE:**

**MEDNET GmbH**  
Borkstrasse 10, 48163 Münster  
Germany

Patents are pending



Ver. 28.7.2016